

SINGER et le Cameo - S - Design sont des marques déposées de The Singer Company Limited S.à.r.l. ou ses sociétés affiliées.
 ©2019 The Singer Company Limited S.à.r.l. ou ses sociétés affiliées. Tous droits réservés.
 SINGER und das Cameo „S“ Design sind exklusive Warenzeichen von The Singer Company Limited S.à.r.l. bzw. zugehörigen Tochterunternehmen.
 ©2019 The Singer Company Limited S.à.r.l. oder damit verbundene Unternehmen. Alle Rechte vorbehalten.
 SINGER e Cameo „S“ Design sono marchi commerciali esclusivi di The Singer Company Limited S.à.r.l. o delle sue affiliate.
 ©2019 The Singer Company Limited S.à.r.l. o sue affiliate. Tutti i diritti riservati.
 SINGER el Cameo „S“ son marcas comerciales exclusivas de The Singer Company Limited S.à.r.l. o de sus afiliados.
 ©2019 The Singer Company Limited S.à.r.l. o sus Afiliados. Todos los derechos reservados.
 SINGER en het ovale „S“ design zijn exclusieve handelsmerken van The Singer Company Limited S.à.r.l. of haar dochterondernemingen.
 ©2019 The SINGER Company Limited S.à.r.l. of haar dochterondernemingen. Alle rechten voorbehouden.

68012386A Singer and the Cameo „S“ design are exclusive trademarks of The Singer Company Limited S.à.r.l. or its Affiliates.
 ©2019 The Singer Company Limited S.à.r.l. or its Affiliates. All rights reserved.
 SINGER och „S“ -emblemet är varumärken tillhörande The Singer Company Limited S.à.r.l. eller dess dotterbolag.
 ©2019 The Singer Company Limited S.à.r.l. eller dess dotterbolag. Med ensamrätt.
 SINGER og „S“-designet i kamé er varemærker tilhørende The Singer Company Limited S.à.r.l. eller dets tilknyttede selskaber.
 ©2019 The Singer Company Limited S.à.r.l. eller dets tilknyttede selskaber. Alle rettigheder forbeholdes.
 SINGER el Cameo „S“ son marcas comerciales exclusivas de The Singer Company Limited S.à.r.l. o de sus afiliados.
 ©2019 The Singer Company Limited S.à.r.l. ta en työpöytä. Kaikki oikeudet pidätetään.
 SINGER och det ovale „S“-symbolen är varumärken tillhörande The Singer Company Limited S.à.r.l. eller dets tilknyttede egenstyper.
 ©2019 The Singer Company Limited S.à.r.l. eller dets tilknyttede selskaber. Med enerett.
 SINGER a Cameo „S“ Design jsou výhradní ochranné známky společnosti The Singer Company Limited S.à.r.l. nebo jejích přidružených společností.
 ©2019 The Singer Company Limited S.à.r.l. nebo jejích přidružených společností. Všechna práva vyhrazena.

1

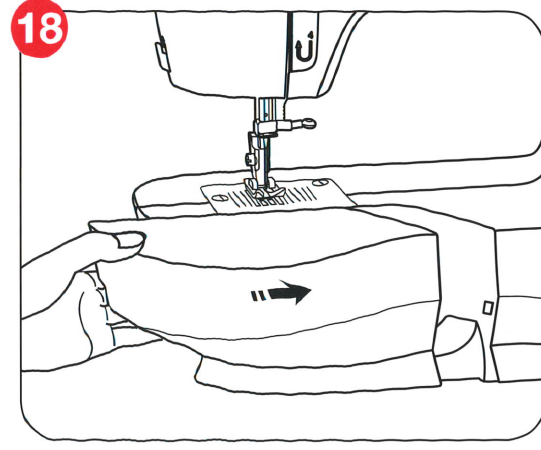
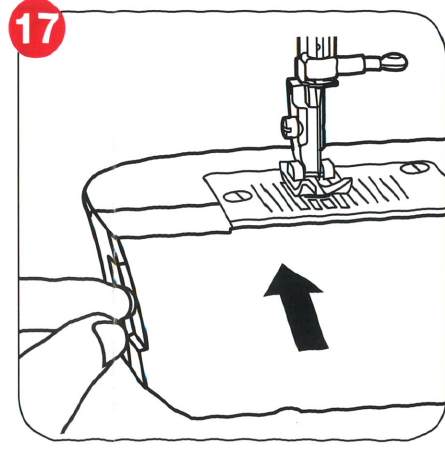
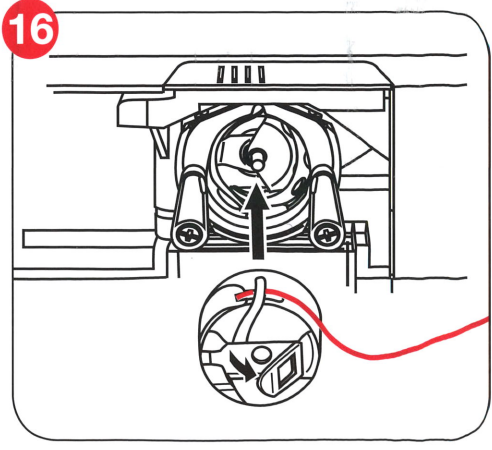
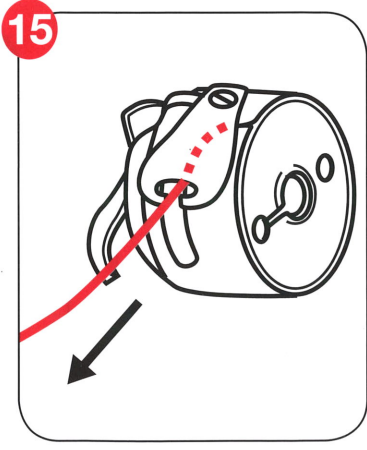
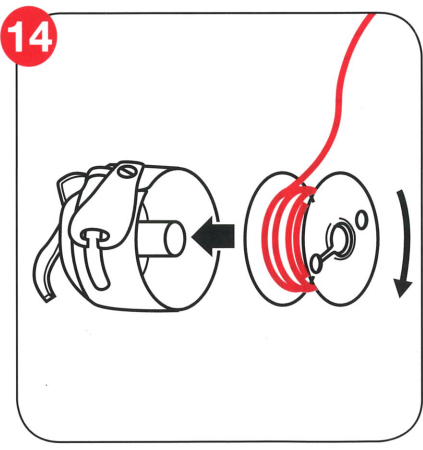
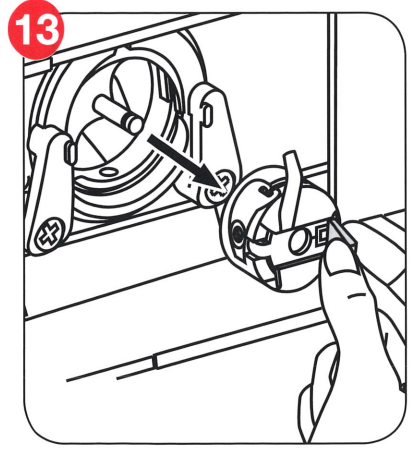
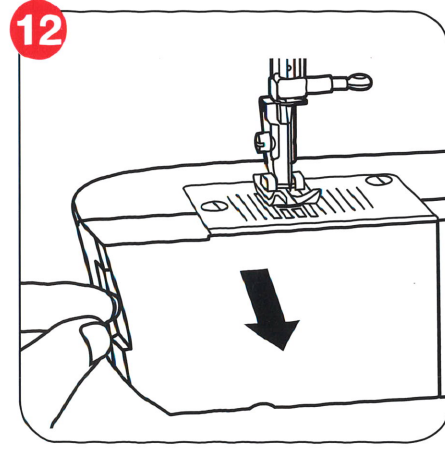
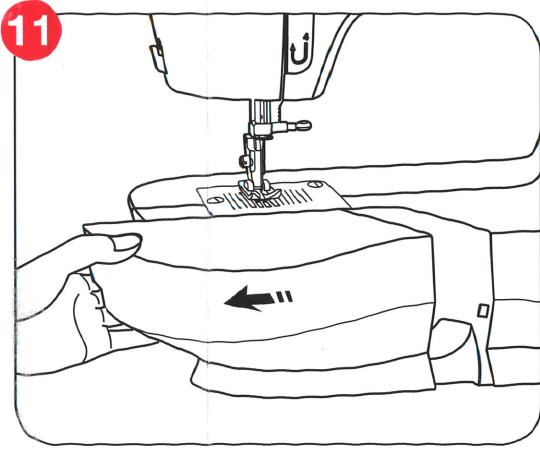
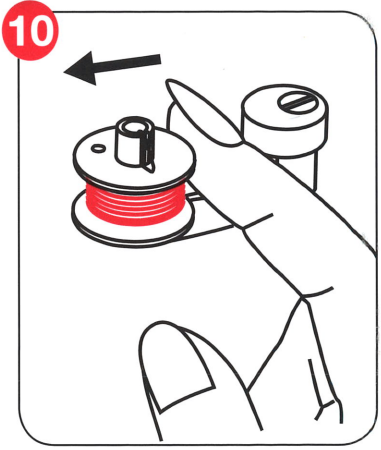
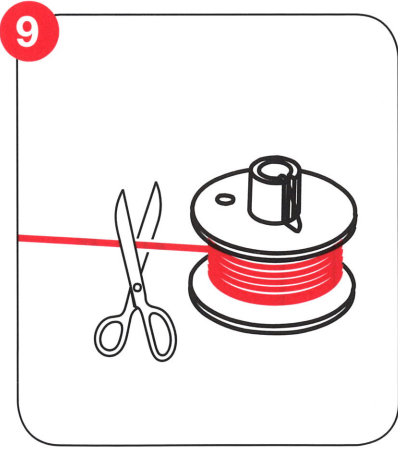
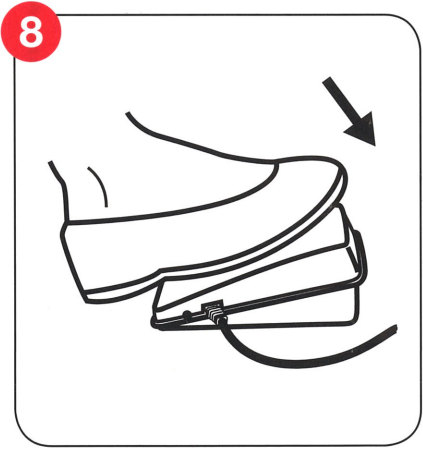
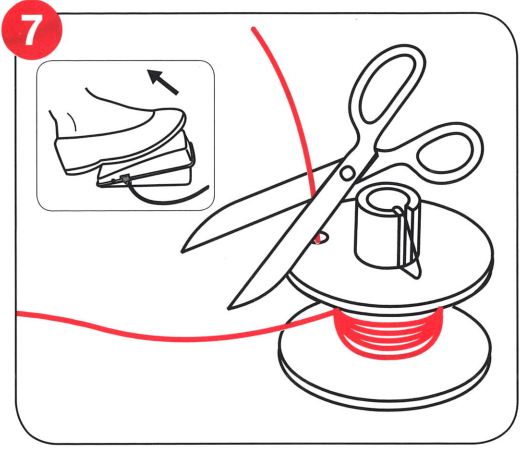
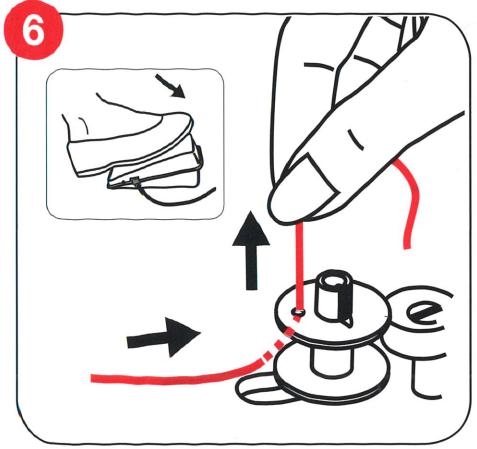
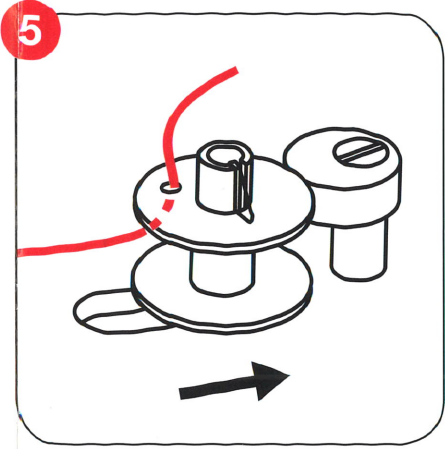
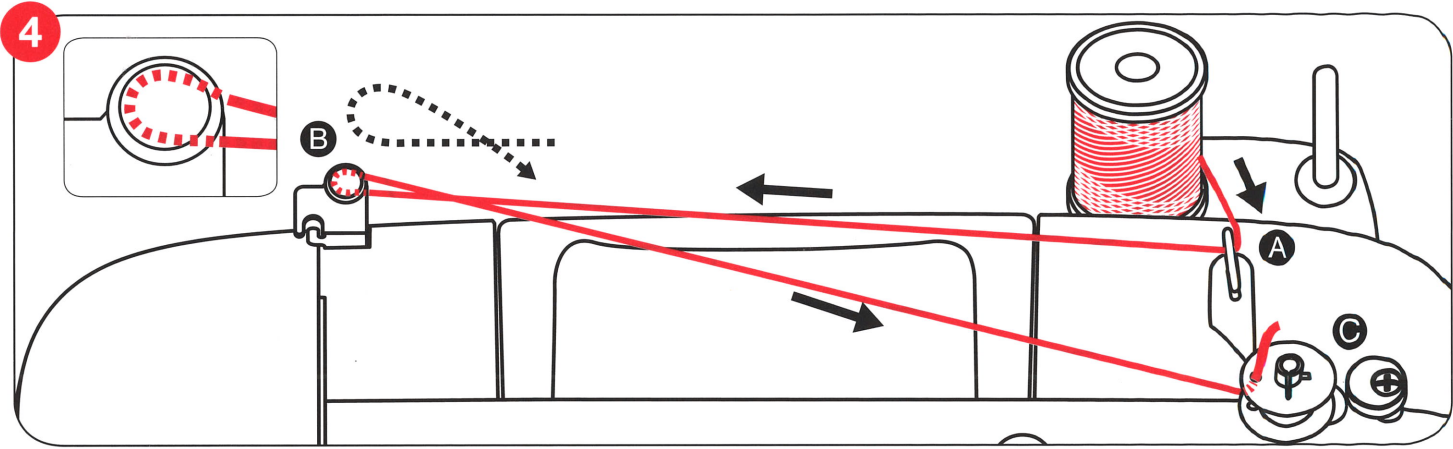
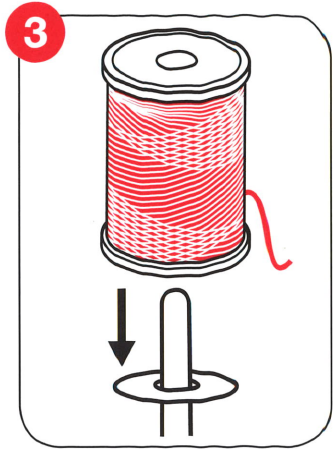
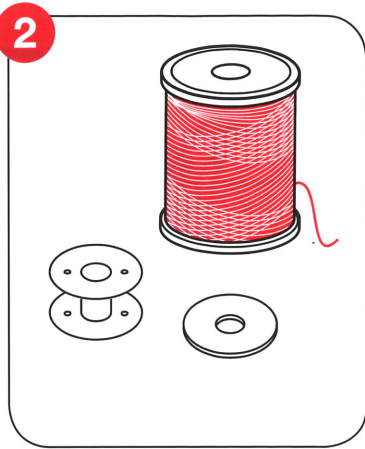
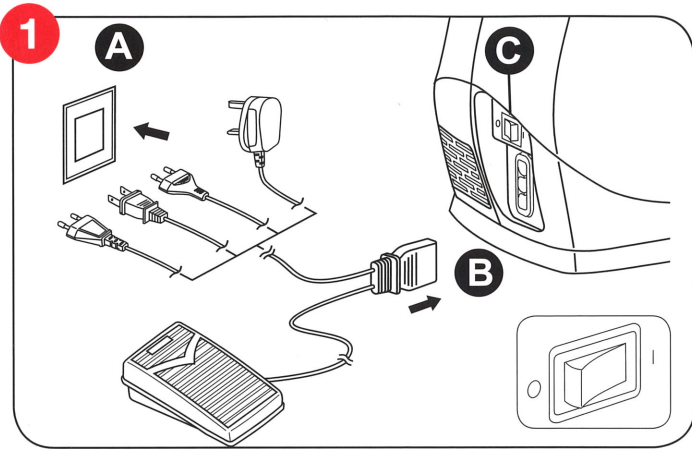
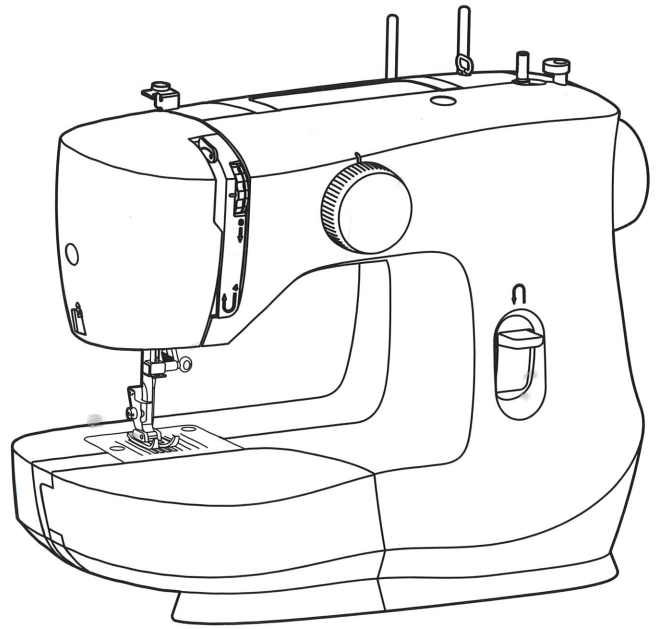
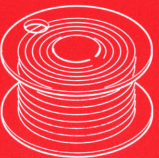

2

